

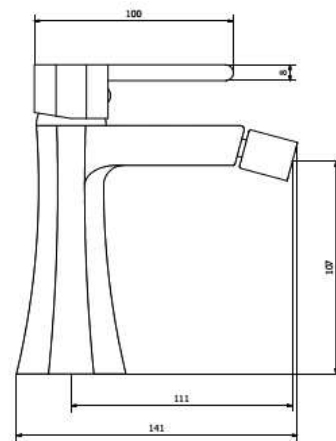

www.ibrubinetterie.it

BELMONDO ELLE
BL220

Range
Product

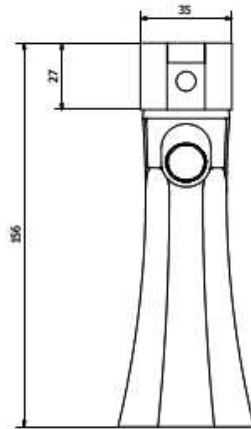

Product Description

Mono hole bidet mixer with the base integrated within the body as single-casted and a metal lever. 1-1/4" click-clack automatic pop-up waste included.

Available Finishings

Chrome	<input checked="" type="checkbox"/>	Glossy Black	<input type="checkbox"/>	PVD Gold	<input type="checkbox"/>	Copper	<input type="checkbox"/>
Brushed Nickel	<input checked="" type="checkbox"/>	Matt White	<input type="checkbox"/>	Gold	<input checked="" type="checkbox"/>	Bronze	<input type="checkbox"/>
Glossy White	<input type="checkbox"/>	Matt Black	<input type="checkbox"/>	Rose Gold	<input checked="" type="checkbox"/>	YO - Your Own	<input checked="" type="checkbox"/>

Tech Specifications

	iB Standard	Possible Alternative													
Cartridge	iB 25 mms Ceramic Discs Cartridge	Flow Restrictions – See below													
Wall Hoses	Flexible Inox 3/8", 450 mms long	Flexible Inox 1/2", 450 mms long Copper Tails PEX Pipes Different lengths available on request													
Aerator	M 28X1														
Flow Rate (+/- 10%)	<table border="1"> <tr><td>1 BAR</td><td>9,5 l/m</td></tr> <tr><td>2 BAR</td><td>13 l/m</td></tr> <tr><td>3 BAR</td><td>19 l/m</td></tr> </table>	1 BAR	9,5 l/m	2 BAR	13 l/m	3 BAR	19 l/m	<table border="1"> <tr><td>0,5 l/m</td></tr> <tr><td>2,5 l/m</td></tr> <tr><td>6,5 l/m</td></tr> <tr><td>9,5 l/m</td></tr> <tr><td>12,5 l/m</td></tr> <tr><td>15,0 l/m</td></tr> <tr><td>18,0 l/m</td></tr> </table> <p>Changing aerator or adding flow restrictors in the hoses, the following range of TOP flow rates can be achieved</p>	0,5 l/m	2,5 l/m	6,5 l/m	9,5 l/m	12,5 l/m	15,0 l/m	18,0 l/m
1 BAR	9,5 l/m														
2 BAR	13 l/m														
3 BAR	19 l/m														
0,5 l/m															
2,5 l/m															
6,5 l/m															
9,5 l/m															
12,5 l/m															
15,0 l/m															
18,0 l/m															
Material	Brass According to CUZN35PB2AL-B(CB752S) Max Lead content: 1,6%														
Production	Main body is a single casted piece														



info@ibrubinetterie.it
 p.iva 01785230986
 capitale sociale €420.000,00 i.v.
 T +39.030.802101
 F +39.030.803097
 iB Rubinetterie SpA
 via dei pianotti, 3/5 - 25068 sarezzo (bs) - Italy

Elenco parti			
ELEM	CODICE	NUMERO DI MAGAZZINO	QT
1	AC0011468	Rectangular lever 15x8 H100	1
2	AC0011467	Handle H27 octagonal 37	1
3	AQ0001100	Grubscrew M5x5 p.p.	1
4	AQ0006650	Plug cover Ø7	1
5	AQ0010280	Inox screw M4X8,5	2
6	AC0012004	Cartridge fixing nut chromed cover	1
7	AQ0006586	OR 25.12x1.78 NBR 70 SH	1
8	AS0011182	Fixing nut M30x1 H17	1
9	AQ0010564	OR 26.7x1.78 NBR 70 SH	1
10	AQ0013098	Cartridge K25 OP S	1
11	AC0010810	Connection piece Ø27X18	1
12	AQ0010972	OR 23x2 NBR 70 SH	1
13	CC0001986	Bidet mixer body	1
14	AQ0010530	Articulated joint M18x1	1
15	AQ0010590	Perlator cachè laminar (44.3330.010)	1
16	AQ0011013	Inox hose G3/8" M M8x1 L450	2
17	AQ0010357	Fixing set	1
18	AQ0009837	Waste	1

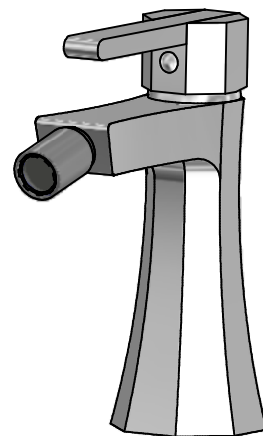
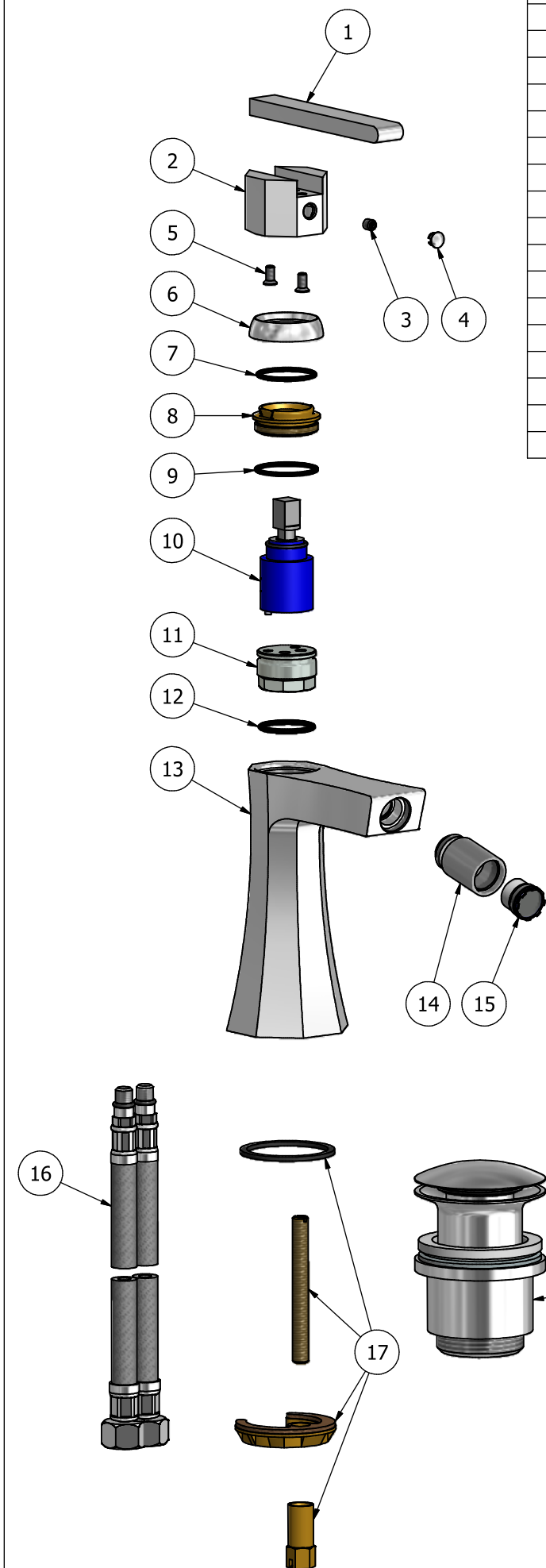

A termini di legge questo disegno non può essere riprodotto senza la nostra autorizzazione

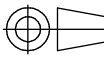
 www.ibrubinerie.it Via del Pianotti 3/5 25068 Sarezze - BRESCIA tel. 030802101 fax. 030803097 www.ibrubinerie.it	Tolleranze generali		Peso	Scala	Formato	
	±0.1			1:2	ISO A3	
	Materiale					
	Disegnatore	Data creazione	Approvato da	Approvato il		
Disegnatore Vivenzi M. Data creazione 16/06/2014 Approvato da Approvato il Denominazione Esplso bidet BelMondo					Codice KBL220CCXN_15	

WARRANTY

all iB Rubinetterie SpA products are warranted for 10 years from the date of purchase, for the following cases:

- defects of casting, porosity and chrome plating
- operating defects caused by incorrect fabrication.

The warranty provides for the repair or replacement of products with fabrication defects recognized by our technical office.

There is no other type of compensation and the merchandise must be returned FOB our warehouse. The warranty only cover surface defects (scartches, dings, etc.) on fittings that have not been installed and used, returned in its original packaging with all components.

O-rings, gasket seals and components subject to wear proportional to use are warranted for 2 years.

The warranty is void in the following cases:

- error installing and putting the product into service.
- deterioration of chrome-plated surfaces due to use of cleaning products containing acids or abrasive substances
- deterioration of surface with finishes other than chrome plating. Their durability is, in fact, dependent on the user's care and gentleness of use.
- deterioration of the fitting due incorrect installation.
- improper repairs and maintenance performed without the company's prior authorization.

The warranty from iB Rubinetterie SpA is not renewable.

Cleaning:

We recommend cleaning chrome-plated and gold-finish surface with water and soap, using a soft cloth.

Do not use detergents that contain hydrochloric acid or abrasive substances.

Plastic parts must only be cleaned with soap and water and soft cloth.

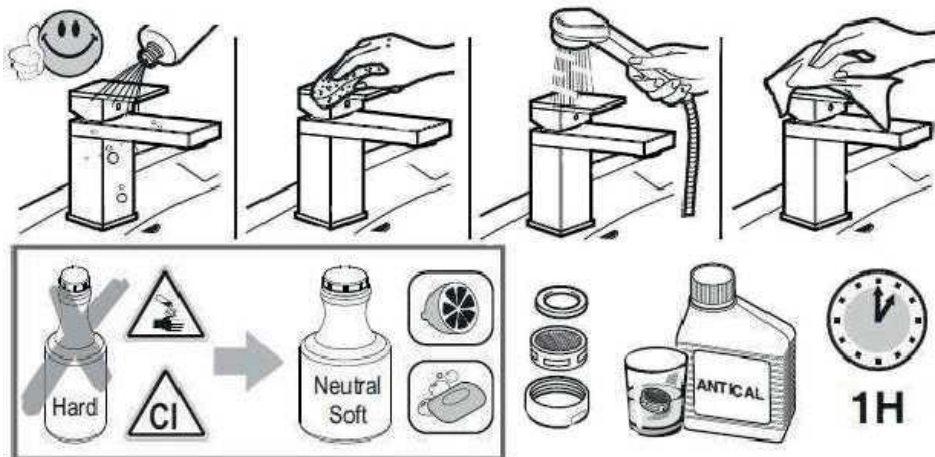

IMPORTANT

Pressure & Temperature Requirements.

- * Hot and cold water inlet pressures should be equal.
- * Inlet pressure range: 150-1000 kPa
- * New Regulation: -500 kPa maximum operating pressure at any outlet within a building. (Ref. AS/NZS 3500.1-2003, Clause 3.3.4)
- * Maximum hot water temperature: 80°C.



iB Rubinetterie S.p.A.
Via dei Pianotti 3/5
25068 SAREZZO (BS) Italy
Iscr. Reg. Impr. BS 01785230986
R.E.A. BS 352087
P.IVA IT01785230986
Capitale Sociale € 420.000,00 i.v.
phone +39 030 802101
fax +39 030 803097
info@ibrubinetterie.it
www.ibrubinetterie.it

